

Single-room decentralised heat recovery unit

# HRU-WALL

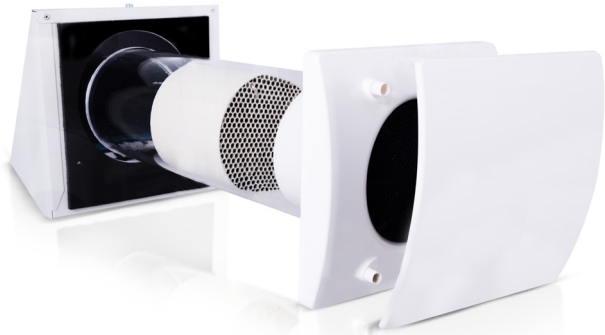

## Description

HRU-WALL is a single-room decentralized heat recovery unit for concealed installation. The unit comes with a ceramic heat exchanger which boasts a maximum heat recovery ratio of 82% (the nominal heat recovery ratio is  $\eta=74.3\%$  as per EN 13141-8:2011).

The energy-efficient EC fan changes the running direction every 70 seconds to alternate between air supply and air exhaust. Low energy consumption and extremely low operating noise make this heat recovery unit a recommended solution for non-stop operation. The heat recovery unit has three speed levels to choose from, depending on the size of the area and indoor demands.

HRU-WALL-100-25 provides a sufficient air change level in areas up to 19m<sup>2</sup>.

HRU-WALL-150-60 provides a sufficient air change level in areas up to 45m<sup>2</sup>.

We recommend installing the devices in pairs.



**Note!**  
The HRU-WALL-...-PEG model has an external, plastic grille.

### Product code example

Product code: **HRU-WALL - 100 - 25**

type \_\_\_\_\_  
 diameter \_\_\_\_\_  
 capacity \_\_\_\_\_

## Dimensions

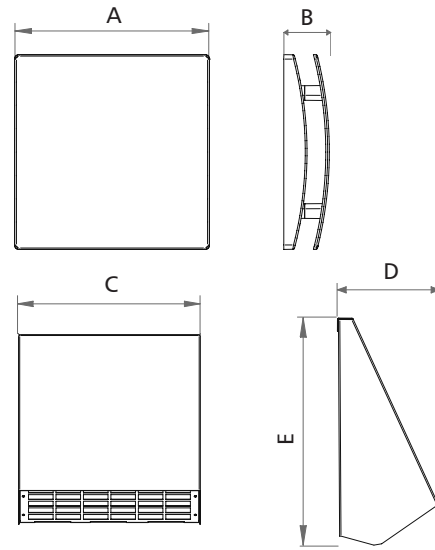

External hood

### HRU-WALL-...-PEG

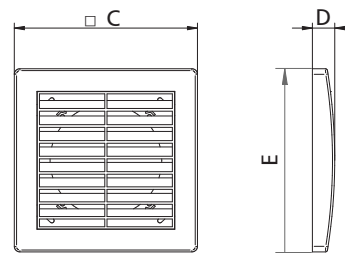

Type	A [mm]	B [mm]	C [mm]	D [mm]	E [mm]
HRU-WALL-100-25	164	46	205	103	209
HRU-WALL-150-60	218	51	252	114	262
HRU-WALL-100-25-PEG	164	46	164	20	164
HRU-WALL-150-60-PEG	218	51	218	20	218

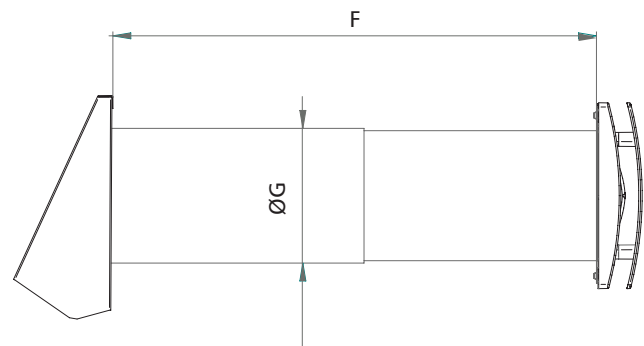

Type	F [mm]	G [mm]
HRU-WALL-100-25	270÷510	108
HRU-WALL-150-60	300÷560	158
HRU-WALL-100-25-PEG	270÷510	108
HRU-WALL-150-60-PEG	300÷560	158

# Single-room decentralized heat recovery unit

## HRU-WALL

### Design of the single-room heat recovery unit

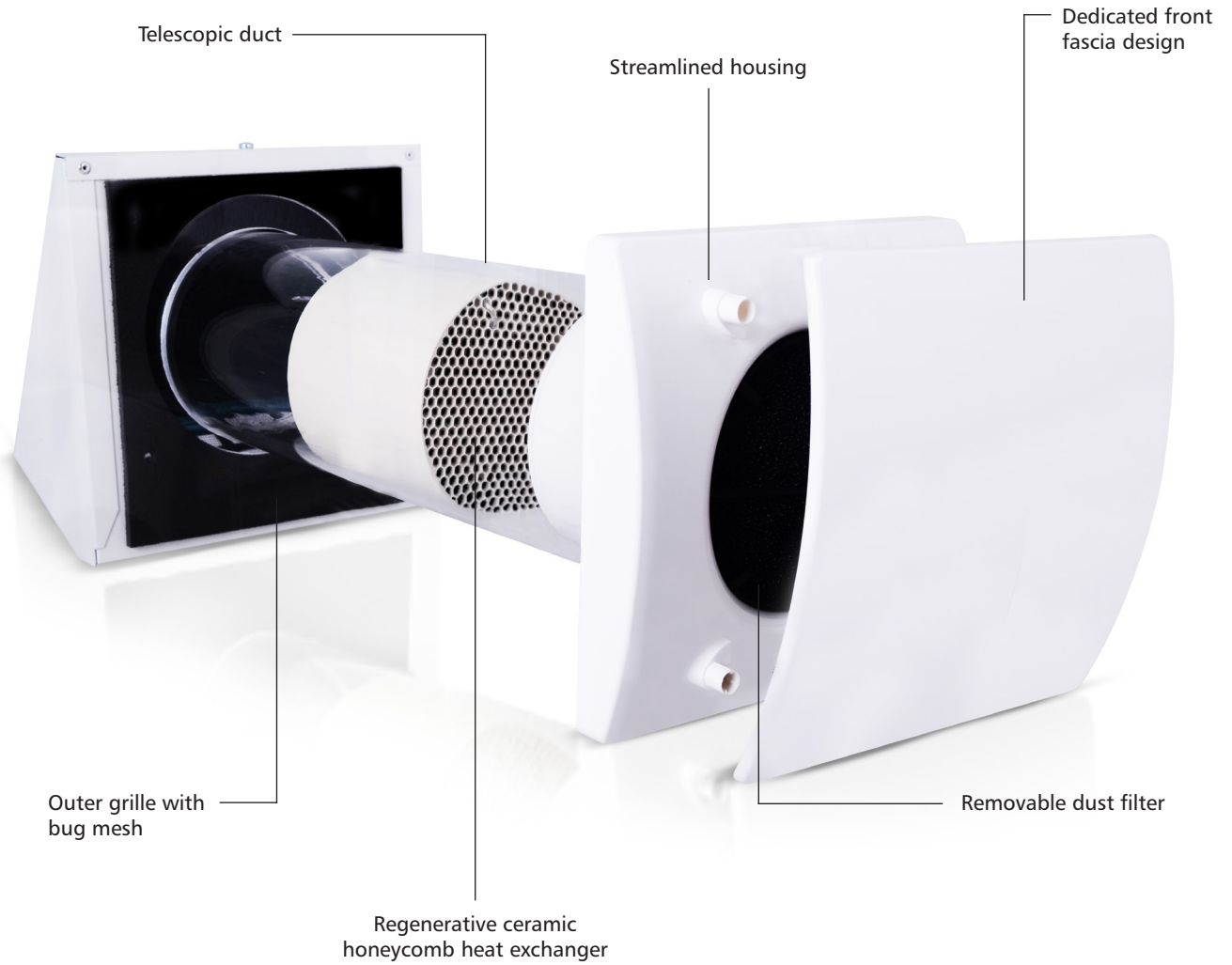

**Note!**  
Power cord is not included.

# Single-room decentralised heat recovery unit

## HRU-WALL

### Other versions

**HRU-WALL-100-25-PEG / HRU-WALL-150-60-PEG**  
with an external, plastic grille



**HRU-WALL-USUA-...-RAL**  
with an external hood, painted in any RAL colour



**HRU-WALL-WREV-150 + HRU-WALL-WREV-FRAME + HRU-WALL-WREV-GRILL**  
a window reveal module for intake and exhaust applications



### Intended use

A system of single-duct decentralized heat recovery units offers the most efficient performance when two identical units are operated in two areas located near one another and connected to a single, common speed controller — HRU-WALL-CONTR-I (or any three-position control switch). This installation configuration allows synchronizing the alternating air flow direction of both units to have one extract air while the other supplies air. An external sensor (which senses relative air humidity or CO<sub>2</sub> level) can be connected in parallel to control the heat recovery system (to increase fan speed if required).

Example temperature values for the 2nd air supply speed

Indoor temp. [°C]	Outdoor temp. [°C]	Air supply temp. [°C]*	
		HRU-WALL-150	HRU-WALL-100
20	0	17.4	16.4
20	-10	16.1	14.6
20	-20	14.8	12.8

\* Supply air temperature measured at the 2nd air supply speed

### How to order

Standard version with metal external hood  
**HRU-WALL-100-25 / HRU-WALL-150-60**

Version with plastic external grille  
**HRU-WALL-100-25-PEG / HRU-WALL-150-60-PEG**

Version with metal hood, painted in any RAL - provide the RAL colour with an order  
**HRU-WALL-...-...-PEG + HRU-WALL-USUA-...-RAL**

Version with window reveal hidden intake-exhaust  
**HRU-WALL-150-60-PEG + HRU-WALL-WREV-150 (flat duct) + HRU-WALL-WREV-FRAME (mounting frame) + HRU-WALL-WREV-GRILL (grille)**

# Single-room decentralized heat recovery unit

# HRU-WALL

## Controller



**HRU-WALL-CONTR-I**  
controller

**Note!**  
Controller is not included in the set,  
sold separately

### Connection of the HRU-WALL-CONTR-I controller

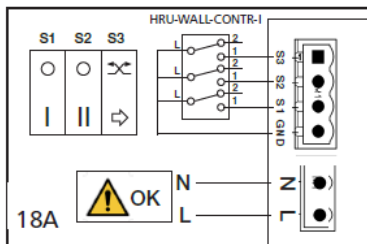

### Connection of 2 HRU-WALL units with a single HRU-WALL-CONTR-I controller

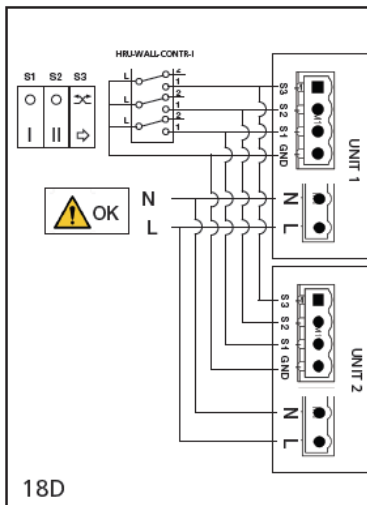

## Energy class

Model	Sound level [dB]	Air flow rate [m³/h]	Energy class
HRU-WALL-100-25	35	10/18/25	A
HRU-WALL-150-60	38	20/40/60	A
HRU-WALL-100-25-PEG	35	10/18/25	A
HRU-WALL-150-60-PEG	38	20/40/60	A

## Technical specifications

Type	Air flow rate [m³/h]	Power [W]	Sound pressure [dB(A)] 3 m	Efficiency [%]	Ambient temp. [°C]	Weight [kg]
HRU-WALL-100-25	10/18/25	1,2/1,7/2,6	10/15/29	74	-20° +50°	2.4
HRU-WALL-150-60	20/40/60	1,4/2,3/3,8	10/18/26	74	-20° +50°	4.3
HRU-WALL-100-25-PEG	10/18/25	1,2/1,7/2,6	10/15/29	74	-20° +50°	2.1
HRU-WALL-150-60-PEG	20/40/60	1,4/2,3/3,8	10/18/26	74	-20° +50°	4.0

Air efficiency measured as per ISO 5801:2008  
Heat recovery efficiency as per EN 13141-8:2011  
Sound level measured as per ISO 3746:2010